

---

# Instruction For Use

## 4-/ 6-Port Line Regulator

L – LINE REGULATOR | T-TEC | L – LOW FLOW

---



---

**IMPORTANT!**

Read carefully before use!

Keep the manual for future consultation!



---

**Factory:**

**GCE Trade s.r.o.**

Ziskova 381

CZ-583 01 Chotebor

Phone: +420 569 661 122

Fax: +420 569 661 107

Sales.cz@gcegroup.com

**GCE Gas Control Equipment Co., Ltd.**

No.4 Building, 318 Xiao Wan Road

Fengxian District, Shanghai 201401

P.R. China

Germany

Phone: +86 21 871 98408

Fax: +86 21 37198617

Sales.cn@gcegroup.com

**Art.-No. IFU-LTL0000**

This instruction is issued by:

GCE GmbH

[www.gcegroup.com](http://www.gcegroup.com)

---

[service.druva@gcegroup.com](mailto:service.druva@gcegroup.com)

---

## Content

Content.....	1
1 General.....	1
1.1 Information about these instruction.....	1
1.2 Information about this line regulator .....	1
1.3 Explanation of symbols .....	2
1.4 Limitation of liability.....	3
1.5 Copyright .....	3
1.6 Spare parts .....	4
1.7 Warranty provisions .....	4
1.8 Kundenservice .....	4
2 Safety.....	4
2.1 Intended use .....	5
2.1.1 Structural changes at the line regulator .....	5
2.2 Fundamental risks .....	5
2.3 Operator’s responsibility.....	7
2.4 Personnel requirements .....	8
2.4.1 Qualifications .....	8
2.4.2 Unauthorized personnel .....	9
2.4.3 Training .....	9
2.5 Personal protective equipment .....	9
2.6 Behaviour in case of fire or accident .....	11
2.7 Environmental protection.....	11
2.8 Signage .....	12
2.8.1 Signs that give orders.....	12
2.8.2 Signs indicating bans .....	12
2.8.3 Warning signs.....	12
3 Technical specifications .....	13
3.1 Dimension sheet LTLJ .....	13
3.2 Dimension sheet LTLF.....	14
3.3 General information.....	15
3.4 Connection values .....	15
3.5 Performance value .....	15

3.6 Operating conditions .....	15
4 Set-up and function .....	16
4.1 Overview LTLJ .....	16
4.2 Overview LTLF .....	16
4.3 Brief description.....	17
5 Transport, packaging and storage .....	17
5.1 Safety information for transportation .....	17
5.2 Transport inspection .....	17
5.3 Packaging .....	18
5.4 Storage .....	18
6 Installation and initial start-up.....	19
6.1 Safety notes for installation and initial start-up .....	19
6.2 Preparation .....	19
6.3 Installation .....	19
6.4 Required qualifications for initial start-up and cylinder changing .....	19
6.5 Initial Start Up .....	20
6.5.1 Fill the process gas tubing with process gas .....	20
6.5.2 Taking gas supply out of operation.....	20
6.6 Tests .....	20
7 Operation .....	20
8 Maintenance .....	21
8.1 Safety notes for maintenance.....	21
8.2 Maintenance plan .....	21
8.3 Maintenance work.....	21
8.3.1 Cleaning .....	21
8.3.2 Requirements for maintenance.....	21
8.3.3 Necessary maintenance.....	22
8.4 Measures following maintenance .....	22
9 Troubleshooting.....	23
9.1 Safety notes for troubleshooting.....	23
10 Dismantling and disposal .....	24
10.1 Safety notes for dismantling and disposal.....	24
10.2 Demontage .....	24
10.3 Disposal.....	25

## 1 General

### 1.1 Information about these instruction

This instruction is only intended for use with line regulator product type: LTLJ – druvaTEC 6-Port and LTLF – druvaTEC 4-Port.

Line regulators of this type are suitable to reduce a high supply pressure through different pressure stages. These regulators were assembled into piping system permanently.

This instruction enables you to operate the system safely and efficiently. These instructions form an integral part of the system and must always be kept with the system and within easy reach of staff at all times.

Prior to commencing any work, the staff must read these instructions carefully and understand the contents. Observance of all the safety information and instructions for operation that are contained in these instructions is essential to ensure work safety.

Local accident prevention regulations and general safety regulations governing the use of the system must also be observed.

Illustrations in these instructions serve to ensure a basic understanding of the system and may differ from the actual version.

### 1.2 Information about this line regulator

Line Regulators of this type are only suitable for gases defined as standard gas. The maximum working pressure for line regulator LTLJ is 300bar, for LTLF it is 50bar.







Standard gases are industrial, inert, flammable and oxidizing gases and/ or their mixtures. Not allowed are the components for corrosive and/ or toxic gases and/or their mixtures.

It is a single stage line regulator with metal diaphragm and six ports.

Created and approved as ISO7291, including oxygen test.

The line regulator consists of the regulator body, inlet and outlet gauge (6-Port Version), outlet gauge (4-Port Version) and pressure relief valve. Different inlet and outlet implementations (compression fittings) are available.

### 1.3 Explanation of symbols

<b>Safety information</b>	Safety information is highlighted by symbols in these instructions. This safety information is preceded by signal words that define the extent of risk.
	<b>DANGER!</b> This combination of symbol and signal word indicates an immediately dangerous situation that will cause death or severe injury if not avoided.
	<b>WARNING!</b> This combination of symbol and signal word indicates a possibly dangerous situation that can cause death or severe injury if not avoided.
	<b>BEWARE!</b> This combination of symbol and signal word indicates a possibly dangerous situation that can cause minor injury if not avoided.
	<b>NOTE!</b> This combination of symbol and signal word indicates a possibly dangerous situation that can cause property and environmental damage if not avoided.
	<b>TIPS AND RECOMMENDATIONS</b> This symbol highlights useful tips and recommendations, together with help for ensuring efficient and trouble-free operation.
<b>Special safety information</b>	The following symbols are used in the safety information to draw your attention to particular risks.
	<b>DANGER!</b> This combination of symbol and signal word indicates an immediately dangerous situation involving electrical current. Ignoring such a warning could result in severe or fatal injuries.

## 1.4 Limitation of liability

All of the information and notes in these instructions have been compiled in accordance with applicable standards and regulations. They reflect best engineering practice and our years of experience.

The manufacturer accepts no liability for damages in the following instances:

- Failure to observe these instructions
- Utilisation of the system for any other than the intended purpose
- Operation by untrained staff
- Unauthorised modifications
- Technical modifications
- Use of unlicensed spare parts
- Working with the c when any safety device is broken or not functional mounted or safety devices don't work correctly
- Improper control of components, connections and gaskets, which are wearing parts.
- Incorrect reparations
- Violation of temperature limits, which are dedicated in the datasheet during operation or storage
- In case of disaster or force majeure



The actual scope of supply may differ from the explanations and illustrations in these instructions following the incorporation of new technical changes.

The obligations stipulated in the supply agreement, our general terms and conditions of business, the manufacturer's terms and conditions of supply and the statutory regulations in force at the time of contract conclusion apply.

## 1.5 Copyright

The contents of these instructions are protected by copyright. They may be used in connection with the operation of the system. Any other use above and beyond the aforementioned is only permitted with the written consent of the manufacturer.

## 1.6 Spare parts

	<p><b>WARNING!</b></p> <p>Risk of injury from using incorrect spare parts!</p> <p>The use of incorrect or defective spare parts can result in risks for the operating staff and in damages, malfunctions or total failure of the system.</p> <p>Only use original spare parts from the manufacturer or spare parts authorized by the manufacturer.</p> <p>Always consult the manufacturer if in doubt.</p>
	<p><b>Loss of warranty</b></p> <p>The manufacturer's warranty lapses if unauthorized spare parts are used.</p>

## 1.7 Warranty provisions

The warranty provisions are included in the manufacturer's general terms and conditions of business. See chapter VI. Warranty Claims.

## 1.8 Kundenservice

<b>Address</b>	GCE GmbH Weyhser Weg 8 36043 Fulda
<b>Telephone</b>	+49 (0) 661 8393 -0
<b>Internet</b>	www.gcegroup.com
<b>E-Mail</b>	service.druva@gcegroup.com

Please do not hesitate to provide us with information and experiences gained through use; we welcome any valuable input that will help to improve our products.

## 2 Safety

This section provides an overview of all the important safety aspects to ensure the protection of your staff and the safe and trouble-free operation of the equipment. Further safety information relating to specific tasks can be found in the sections on the individual life cycle phases.



## 2.1 Intended use

The LTL line regulator is only usable for the defined standard gases and pressures observing the given temperature range. The nominal flow is 20 m<sup>3</sup>/h.

Intended use also includes compliance with all the information in these instructions and compliance with reparation, maintenance working, type label and data sheets.

Any use other than, or above and beyond, the intended use constitutes improper use.



### **WARNING!**

Danger from improper use!

Improper use of the system can lead to dangerous situations.

Never use the regulators as a means of regulating flow or as a shutoff valve in the system.

Never use the line regulator with liquid fluids.

### 2.1.1 Structural changes at the line regulator

Without written approval of supplier no extensions, additions or alternations are allowed on the line regulator.

Components which are not in perfect condition have to be changed immediately.

#### **Cleaning of line regulator and disposal of residues**

Used components which are ready for reparation has to be purged with an inert gas before.





#### **Noise Generation**

In some cases when specific influence quantities collaborate together, e.g. flow and pressure range can cause noise generation or the gas itself. If this happens please contact supplier.

## 2.2 Fundamental risks

The following section addresses the residual risks that may arise, even if the system is used properly.

Observance of the safety information included below and in other sections of these instructions is mandatory in order to reduce the risk of injury and property damage and to avoid dangerous situations.

	<p><b>Danger!</b>  <b><u>Gases</u></b> can be life threatening!  Gases can supersede the oxygen in air. This can result in death by asphyxiation. Oxygen produces a strongly oxidizing effect.  Therefore:  Sufficient ventilation is absolutely essential.  Installation only through certified company.  Observe ATEX-directive</p>
	<p><b>Attention!</b>  Risk of injury from <b><u>environment!</u></b>  There can be malfunctions on line regulator due to condensation and/ or icing.  Therefore:  Observe suitable temperatures.  Protect line regulator from liquids from outside  Protect line regulator from dust from outside  Protect line regulator from weather conditions  Grounding has to be mounted properly</p>
	<p><b>Warning!</b>  Risk of injury from using <b><u>oil and grease!</u></b>  Oil and grease must never be used in gas regulating systems. Oil and grease are highly inflammatory and can react violently to certain pressurized gases.  Therefore:  Never use oil and grease</p>
	<p><b>Warning!</b>  <b><u>Risk of injury</u></b> from residual energy stored in the system!  If handled incorrectly, pressurized components can move uncontrollably and cause severe injury. If handled incorrectly or defective, pressurized components can leak gas under high pressure and cause severe or even fatal injuries.  Before starting work with these components:  Installation only through certified company.  Always wear protective goggles when working.  Make sure the equipment is depressurized. Also make sure the residual energy is discharged.  Always ensure that gas cannot leak unintentionally.  Make sure that defective components that are pressurized during operation are immediately replaced by trained staff.</p>

	<p><b>Warning!</b>          Danger of <b><u>accident!</u></b>          Due to wrong installation there can be serious or even mortal injuries.          Therefore:          During installation the component should be kept safe          Never throw the component</p>
---	--

Pressurised components are only for intended use.

If there are mechanical damages at tubing or components the whole system has to be put in a safe condition. Affected area has to be blocked.

Troubles which could influence safety, have to be eliminated through qualified staff or supplier.

Especially with gases failure in pressure regulator could happen. Indications for defective regulator is no flow or immediately rising outlet pressure. In this case system has to be shut-off and the relevant department for maintenance has to be informed. Never close exhaust piping

## 2.3 Operator's responsibility

### Operator

The operator is the person who operates the system for commercial or business purposes or who provides the system for use/application by a third party, and who bears legal product responsibility for protecting the user, staff or third parties during operation.

### Operator's duties

The system is used for commercial purposes. The operator of the system is therefore subject to legal work safety obligations.

Compliance with the safety, accident prevention and environmental protection regulations that apply for the use of the system is mandatory, in addition to the safety information in these instructions.

The following applies in particular:

- The operator must be aware of the applicable work safety regulations and must perform a risk assessment to identify risks that may occur as a result of the specific working conditions at the site where the system is operated. The operator must use this assessment as the basis for compiling instructions for operating the system.
- During the entire period in which the system is operated, the operator must ensure that these operating instructions comply with the latest regulations, and must update the instructions if necessary.
- The operator must assign clear and specific responsibility for installation, operation, troubleshooting, maintenance and cleaning.
- The operator must ensure that all members of staff who work with the system have read and understood these instructions. The operator must also ensure that these members of staff are trained at regular intervals and are aware of the risks.

- The operator must provide the staff with the requisite protective equipment and bindingly obligate the staff to wear the necessary protective equipment.

In addition, the operator is responsible for ensuring full technical reliability of the system at all times. As such, the following applies:

- The operator must ensure compliance with the maintenance intervals specified in these instructions.
- The operator must ensure that all safety equipment is regularly inspected for functional reliability and completeness.

## 2.4 Personnel requirements

### 2.4.1 Qualifications

The various tasks described in these instructions constitute differing requirements in respect of the qualifications of the staff charged with performing these tasks.

	<p><b>Warning!</b></p> <p><b><u>Danger if staff is insufficiently qualified!</u></b></p> <p>Insufficiently qualified staff is not able to assess the risks associated with the system and expose both themselves and others to the risk of severe or fatal injury.</p> <p>Ensure that all works are only performed by staff qualified for the specific task.</p> <p>Keep insufficiently qualified people out of the work area.</p>
--	--

The works must always be assigned only to individuals who can be trusted to perform the works reliably. People with impaired reactions, e.g. as a result of drugs, alcohol or medication, must not be allowed to perform works.

These instructions define the qualifications below that are necessary for the respective tasks:

#### **Gas engineer:**

Have a professional training, skills and experience and the knowledge of the pertinent standards and regulations to perform works on gas systems and to identify potential hazards. Gas engineers are trained specifically for the site where they work and are familiar with all relevant standards and regulations.

#### **Technician**

Have the professional training, skills and experience and the knowledge of the pertinent standards and regulations to perform the assigned works and to identify and avoid potential hazards.

### 2.4.2 Unauthorized personnel

**Warning!**

Risks associated with unauthorized personnel in the hazard and work areas can be life threatening!

Unauthorized individuals without the qualifications described in this section are not familiar with the risks in the work area. As such, they are in danger of severe or even fatal injury.

Keep unauthorized personnel away from the hazard and work area.

If in doubt, approach individuals and instruct them to leave the hazard and work area.

Stop any work while unauthorized individuals are in the hazard and work area.

### 2.4.3 Training





The operator must train the staff at regular intervals. A training log must be maintained for purposes of better tracking and must contain the following information, at least:

- Date of training
- Names of trained staff
- Contents of the training session
- Name of trainer
- Signatures of the staff members in training and of the trainer

### 2.5 Personal protective equipment

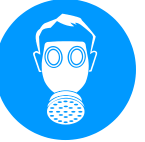
Personal protective equipment protects staff from safety and health hazards while working.

Various tasks on and associated with, the system necessitate the use of personal protective equipment, which is described in more detail in the individual sections of these instructions.

	<p><b>Breathing apparatus</b></p> <p>To protect against harmful gases, vapours, dust and similar materials and media.</p> <p>Breathing apparatus (e.g. compressed air respirator) must be used when an oxygen content of at least 17% in the ambient air is not guaranteed or when the limit of a hazardous substance in the ambient air is exceeded more than 100-fold.</p> <p>Breathing apparatus may only be worn by people who have been specially trained in the use.</p>
	<p><b>Breathing apparatus, dependent on air circulation</b></p> <p>To protect against harmful gases, vapours, dust and similar materials and media.</p> <p>Breathing apparatus must be worn if a permissible limit is exceeded 100-fold.</p> <p>The breathing apparatus may only be used when the oxygen content in the ambient air measures at least 17%.</p>
	<p><b>Protective goggles</b></p> <p>To protect the eyes against airborne parts and splashes of liquid.</p>
	<p><b>Chemical-resistant gloves</b></p> <p>To protect the hands from aggressive substances.</p> <p>Make sure the protective gloves are leak-proof before wear, Before taking the gloves off, clean them and then store them in a well ventilated location.</p>
	<p><b>Protective gloves</b></p> <p>To protect the hands against abrasion, scrapes, pricks or deeper injuries and contact with hot or cold surfaces.</p>
	<p><b>Wear Hearing Protection</b></p> <p>Protect the ears from loud noises and prevent an acoustic trauma.</p>

## 2.6 Behaviour in case of fire or accident

### Preventive Measure

- Always be prepared for fires and accidents!
- Always keep first aid equipment (kit, blankets, etc.) and fire extinguishing equipment in working order and close to hand.
- Familiarize the staff with accident reporting, first aid and emergency procedures.
- Keep the access routes free for emergency service vehicles.

### Measures in the event of fire or accident

- If there is no risk to your own safety, remove people from the danger zone.
- Administer first aid if necessary.
- Notify the fire brigade and/or emergency service.
- In the event of fire: If there is no risk to your own safety, use fire extinguishing equipment to fight the fire until the fire brigade arrives.
- Inform the person responsible at the location.
- Make sure the access routes are free for emergency service vehicles.
- Direct the emergency service vehicles.

## 2.7 Environmental protection

	<p><b>NOTE!</b></p> <p>Risk of environmental pollution from incorrect handling of environmentally hazardous substances!</p> <p>The environment can suffer substantial damage if environmentally hazardous substances are handled, and especially disposed of, incorrectly.</p> <p>Always observe the information below on handling environmentally hazardous substances and their disposal.</p> <p>Take immediate measures if environmentally hazardous substances are accidentally released into the environment. If in doubt, notify the responsible local authorities about the damage and enquire about the suitable measures to be taken.</p>
---	--

## 2.8 Signage

The following symbols and warning signs are located in the work area. They relate to their immediate vicinity.

	<p><b>WARNING!</b></p> <p>Danger from illegible signs!</p> <p>Labels and signs can gather dirt or become otherwise illegible over time, thus preventing the recognition of risks and compliance with the requisite operating information. This could result in injury.</p> <p>Make sure all safety, warning and operation information is legible at all times.</p> <p>Immediately replace any damaged signs or labels.</p>
---	--

### 2.8.1 Signs that give orders

- No signs

### 2.8.2 Signs indicating bans

- No signs

### 2.8.3 Warning signs



Gas Bottles Hazard



Explosion- Hazardous Area



Warning of Toxic Substances



### 3 Technical specifications

#### 3.1 Dimension sheet LTLJ

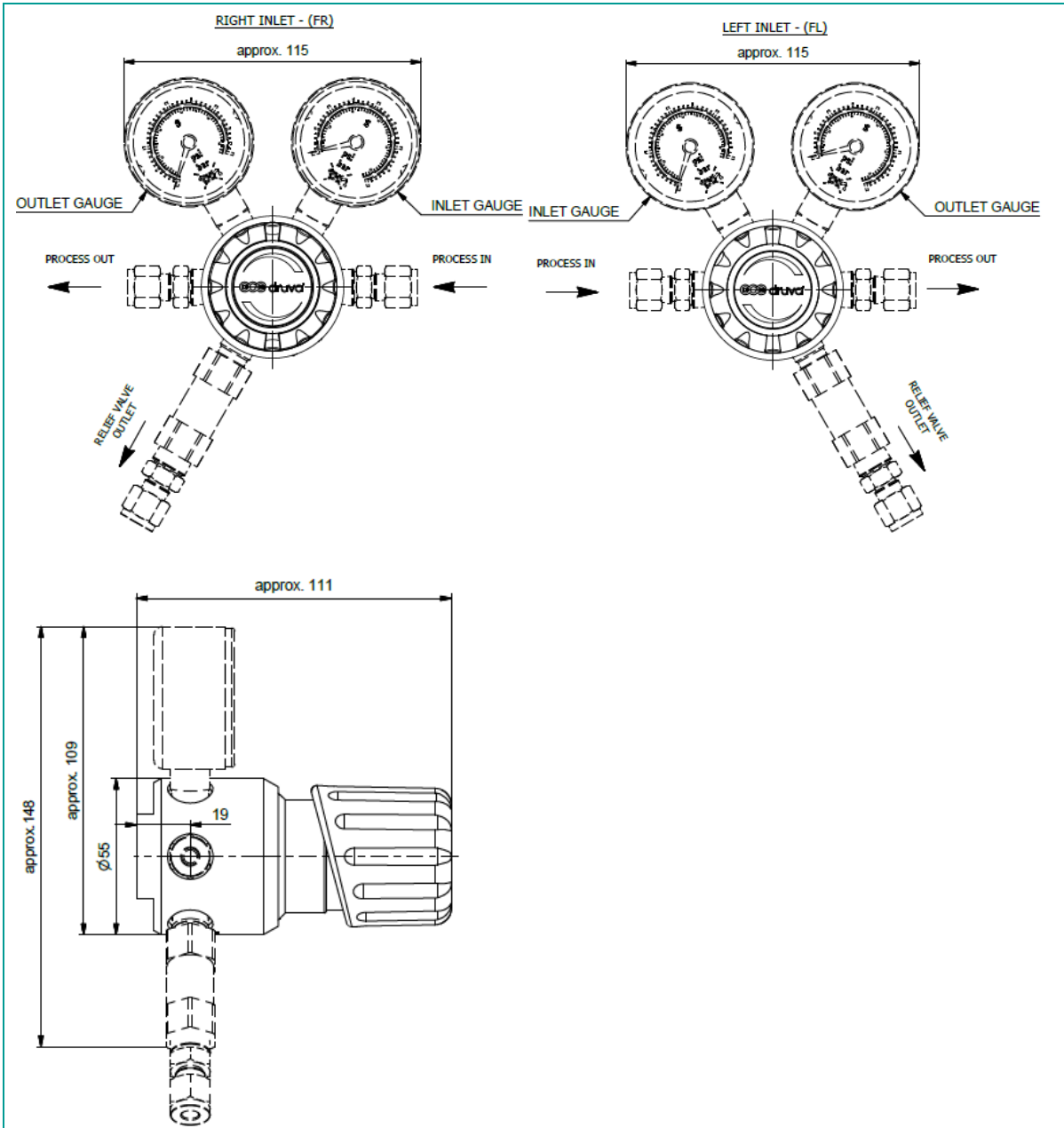

**3.2 Dimension sheet LTLF**

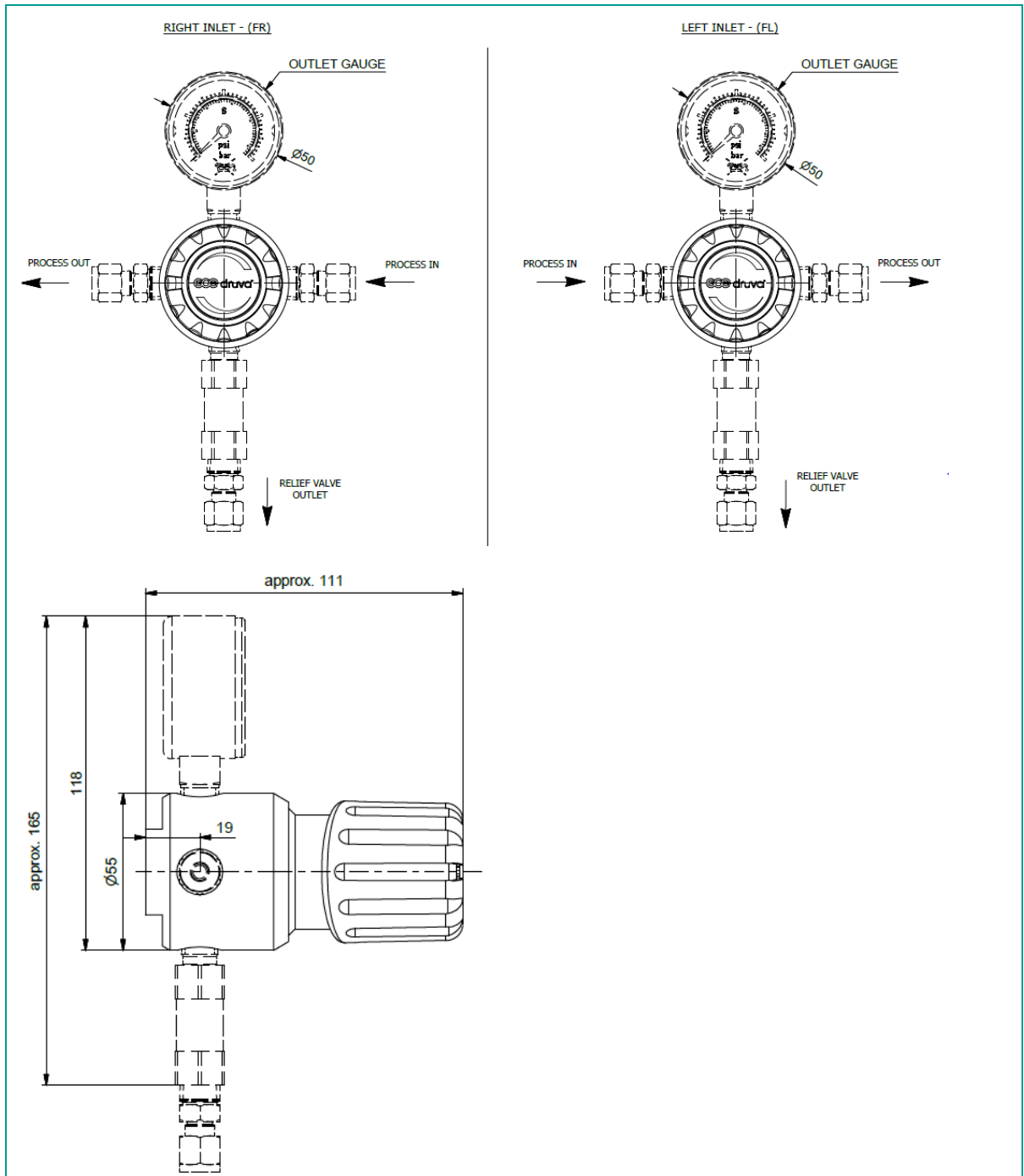

### 3.3 General information

Information	Value	Unit
Weight	Approx. 1,5	kg
Length	115	mm
Depth	111	mm
Height	148 (LTLJ)	mm
	165 (LTLF)	mm

### 3.4 Connection values

Information	Value	Unit
Inlet	¼"	NPT female
	6, 8, 10, 12	fitting mm
Outlet	¼"	NPT
	6, 8, 10, 12	fitting mm
Outlet relief valve	¼"	NPT female
	6, 8, 10, 12	fitting mm

### 3.5 Performance value

Information	Value	Unit
Nominal flow	20	m <sup>3</sup> /h
Inlet pressure(max.)	300 (LTLJ)	bar
	50 (LTLF)	bar
Outlet pressure (max.)	10-100 (LTLJ)	bar
	2,5-16 (LTLF)	bar

### 3.6 Operating conditions

Information	Value	Unit
Temperature range	-20 till +60	°C
Relative humidity (max.)	98	%

## 4 Set-up and function

### 4.1 Overview LTLJ

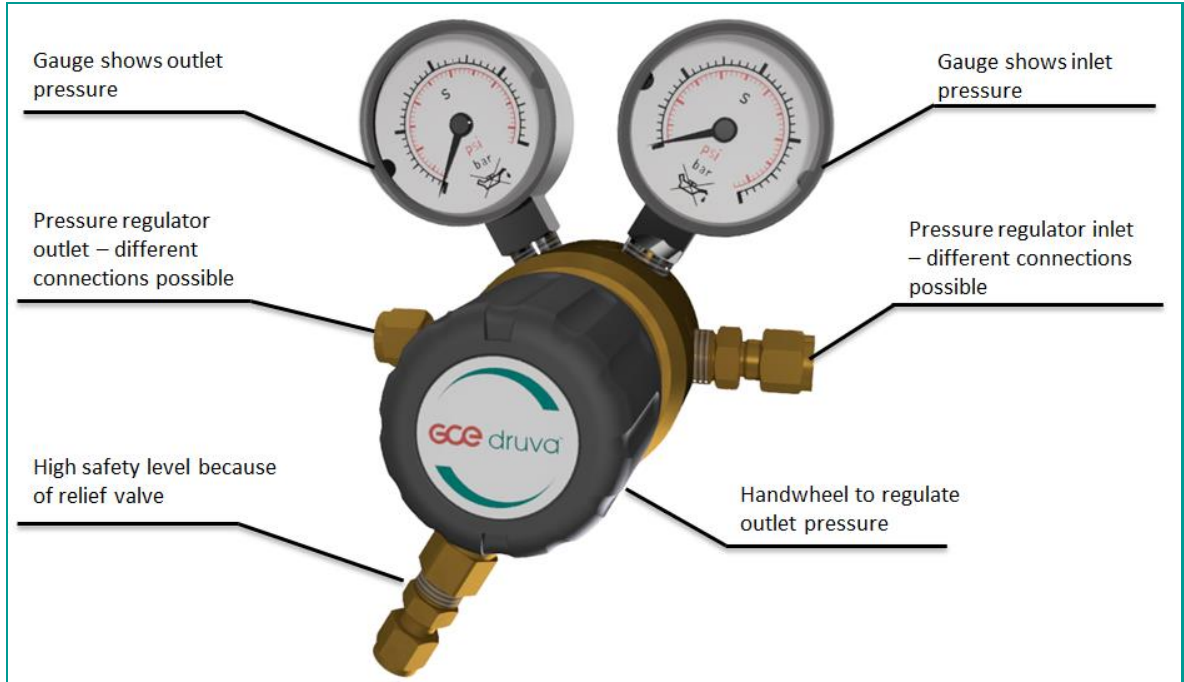

### 4.2 Overview LTLF

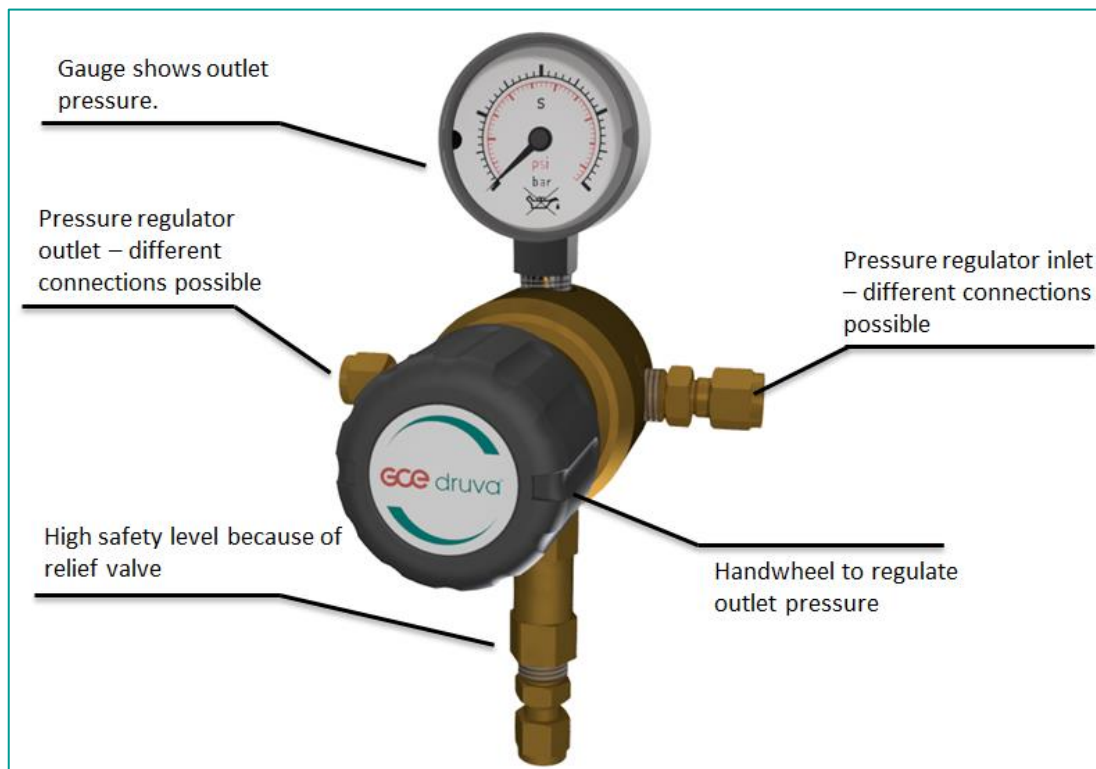

### 4.3 Brief description

The operation of the line regulator LTLJ works manual with the handwheel. The inlet and outlet pressure is displayed on the inlet and outlet gauge at 6-Port version. At 4-Port version only the outlet pressure is displayed at the outlet pressure gauge.

## 5 Transport, packaging and storage



The installation and start- up of this component is normally done by the supplier or by authorized personnel.

Even though there can be some users or maintenance personnel who care about the packaging. The following notes should be observed accordingly.

### 5.1 Safety information for transportation



#### NOTE!

Damages caused by **inappropriate transportation!**

If transported inappropriately, consignments can fall or topple over. This can cause considerable property damage.

When unloading the consignments on delivery and transporting them on the premises, act with caution and observe the symbols and warnings on the packaging.

Use only the attachment points provided.

Do not remove the packaging until you are ready to assemble the regulator.

### 5.2 Transport inspection

Upon delivery, check immediately that the consignment is complete and has not been damaged during transit. Procedure on detection of visible transport damage:

- Refuse acceptance of the delivery or only accept subject to reservation
- Record the extent of the damage on the transportation documentation or on the forwarder's delivery note
- File a complaint



Report each and every defect as soon as you discover it. Claims for damages can only be asserted within the specified periods.

### 5.3 Packaging

The individual consignments are packed according to the anticipated transport conditions. Without exception all packaging is made of environmentally friendly material.

The packaging is intended to protect the individual components against transport damage, corrosion and other damage until they are ready for installation. Do not, therefore, destroy the packaging; only remove it when assembly is imminent.

	<p><b>NOTE!</b></p> <p>Risk of environmental harm through incorrect disposal!</p> <p>Packaging materials are valuable raw materials. In many cases they can be re-used or recycled. Incorrect disposal of packaging materials can harm the environment.</p> <p>Dispose of packaging materials in an environmentally compatible manner.</p> <p>Observe locally applicable disposal regulations. If necessary, commission a specialist disposal firm.</p>
---	---

### 5.4 Storage

Store the packages in the following conditions:

- Do not store outdoors
- Store in a dry and dust-free location
- Do not expose to aggressive media
- Protect from sunlight radiation
- Avoid mechanical jolts
- Storage temperature: 15 to 35 °C
- Relative humidity: max. 60 %
- If storing for longer than 3 months, regularly inspect the general condition of all parts and the packaging. If necessary re-apply or renew the rust-proofing

	<p>Some packages may bear labels with storage information that extends beyond these requirements. These notes should be observed accordingly.</p>
---	---

## 6 Installation and initial start-up

### 6.1 Safety notes for installation and initial start-up

#### Staff

Installation and initial start-up of the system may only be performed by qualified staff.

### 6.2 Preparation

#### Unpacking

- The system components should be removed from their packaging carefully and prudently.
- Additional protective packaging should also be removed.
- Check all components of damages from transport

#### Depressurize

- Depressurize components and purge with inert gas if necessary
- Cut tubing with special tool; avoid contaminations (dirt, cuttings, etc.)
- Check perfect condition of components and purity of connections

### 6.3 Installation

In most cases the line regulator is mounted with compression fittings. First remove the plastic caps from inlet and outlet. The piping has to be insert completely into the compression fitting. Than screw the nut hand tight. After that screw with a jaw spanner 1 ¼ turns tight. Connect the relief tubing the same way.

### 6.4 Required qualifications for initial start-up and cylinder changing

- The test protocols from the piping according to tightness and if necessary moisture and particles are available
- In process gas tubing is only standard gas ( see 1.2)
- The start-up is only realized by qualified personal
- Wear safety clothes according to regulations
- Before first start-up check type label, if the line regulator is suitable for the provided purpose (gas, pressure, material, etc.)

## 6.5 Initial Start Up

- All requirements are fulfilled as on point 6.4
- Pressure regulator is depressurized, handwheel turned completely to left side



### **WARNING!**

Make sure the components are not exposed to pressure levels that exceed their respective permissible nominal pressure.

### 6.5.1 Fill the process gas tubing with process gas

Adjust pressure with handwheel turning clockwise. Line Regulator is now in operation. We recommend checking the pressure at pressure gauges on daily bases.

### 6.5.2 Taking gas supply out of operation

Close line regulator by turning the handwheel anti clockwise.

Depressurize tubing system.

Line regulator is now out of operation. Now reparation and/ or maintenance work could be done.

## 6.6 Tests

- After pressurizing the complete function of line regulator should be tested.
- Check relief valve, it has to be bubble tight

## 7 Operation

In reference to chapter 2.1 the operation of line regulator is defined.



### **BEWARE!**

Line regulators must always be opened slowly and carefully to prevent pressure surges in the system and damage to the other components!



## 8 Maintenance

### 8.1 Safety notes for maintenance

	<p><b>NOTE!</b></p> <p>Maintenance may only be performed by sufficiently qualified, trained and authorized individuals (see section 2.4)</p>
--	--

### 8.2 Maintenance plan

The following sections describe the maintenance works that must be performed to ensure the optimum and trouble-free operation of the regulator.

If regular inspections reveal increased wear, the requisite maintenance intervals must be shortened to reflect the actual wear and tear.

	<p><b>NOTE!</b></p> <p>Please contact the manufacturer if you have any questions relating to maintenance works and intervals (see 1.8 for contact details).</p>	
<b>Intervall</b>	<b>Maintenance work</b>	<b>Personal</b>
<b>Weekly</b>	Check line regulator and gauges visual	Gas-Engineer
<b>Every year</b>	Checking function and tightness	Gas-Technician
<b>Every 10 years</b>	General overhaul and replacement of all wearing parts.	Gas-Engineer

### 8.3 Maintenance work

#### 8.3.1 Cleaning

	<p><b>NOTE!</b></p> <p>All cleaning agents must be compatible with the materials of the installed component.</p>
--	--

#### 8.3.2 Requirements for maintenance

- Check before maintenance start, if
- no gas supply is connected to the line regulator
  - line regulator is depressurized
  - no process gas is inside the line regulator
  - line regulator is purged and filled with Nitrogen

### 8.3.3 Necessary maintenance

- Line regulator and gauges: check condition, function and labelling
- Check labelling
- Check for corrosion
- Check function
- Check the accuracy of pressure gauges
- Pressure test with 1-times working pressure for 12 hours
- Worn and defective components have to be changed immediately from authorized qualified company
- If there is leakage or corrosion at the line regulator, regulator has to be changed immediately from authorized qualified company
- After the changing of components or tubes, pressure and leakage test have to be done again and be protocolled

### 8.4 Measures following maintenance

The following steps must be performed when the maintenance works have been completed and before switching on the system.

1. Make sure that all tools, materials and other equipment have been removed from work area.
2. Clean the work area and remove any spilled substances, e.g. liquids, processing material or similar.
3. Make sure that safety relevant components are working perfect.

## 9 Troubleshooting

The following section describes possible causes of malfunctions and how to eliminate them.

If malfunctions occur with increasing regularity, shorten the maintenance intervals to reflect the actual load.

If malfunctions occur that cannot be eliminated with the following help, please contact the manufacturer (see section 1.8 for contact details).

### 9.1 Safety notes for troubleshooting

In any case of malfunction the shut-off valves of the connected gas containers have to be closed. Never operate devices with malfunction under pressure.

What to do in case of malfunction

1. Interrupt gas supply
2. Depressurize line regulator with handwheel
3. Only trained technical staff may eliminate malfunctions.
4. Restore the line regulator to its original state.

No.	Description of fault	Cause	Solution
1	No flow	Pressure regulator closed Inlet shut off valve closed Purge valve open Cylinder valve closed	Open pressure regulator Open inlet shut off valve Close purge valve Open cylinder valve
2	Increasing outlet pressure, relief valve opens	Leakage at pressure regulator seat	Service through manufacturer
3	Increasing outlet pressure, Relief valve does not open	Emptying of gas cylinder, thereby pressure drop, 50 bar version, reason inlet pressure drop	No failure, standard operation condition
4	Slight outlet pressure drop	Difference between "no flow" and flow	No failure, standard operation condition
5	Massive outlet pressure drop	Flow too high for pressure regulator	Choose new line regulator for needed pressure and flow
6	Noises during operation	Flow too high for pressure regulator	Choose new line regulator for needed pressure and flow
7	Moisture on pressure regulator	Pressure regulator withdraw energy from the	No failure, standard operation condition

	(NO thaw, rain or snow)	environment because of depressurizing	
8	Icing at pressure regulator (NO thaw, rain or snow)	Pressure regulator withdraw energy from the environment because of depressurizing  Flow to high (N2O, CO2)	Kein Fehler, nomaler Bestriebszustand ACHTUNG: auf Funktionalität der Kontaktmanometer achten Anzahl der Druckgasbehälter erhöhen
9	Outlet pressure too high	Regulator is adjusted wrong Seat is broken or dirty	Correct adjustments Maintenance of regulator
10	Relief valve opens	Inlet pressure is higher than approved	Check inlet pressure
11	No flow	Relief valve open	Close relief valve

## 10 Dismantling and disposal

Once the system has reached its end-of-life, it must be dismantled and disposed of in an environmentally compatible way.

### 10.1 Safety notes for dismantling and disposal



#### WARNING!

Risk of injury through ***incorrect dismantling!***

Residual energy storage, sharp edged components, tips and corners on and in the system or on the required tools can cause injury.

- arrange enough space for working
- be careful with sharp edges
- pay attention for order and cleanness
- loose components can cause accidents
- Dismantle the components properly. Bear in mind that some of the components are heavy. Use lifting equipment if necessary
- Secure the components against falling or toppling over

### 10.2 Demontage

#### Prior starting dismantling

Depressurize line regulator by turning the handwheel anti clockwise

Depressurize line regulator and make sure that there is no process gas inside

Dismantle the assemblies and components properly and in compliance with applicable local work safety and environmental protection regulations.

### 10.3 Disposal

In the absence of a return or disposal agreement, the dismantled components should be recycled as follows:

Metals: scrap.

Plastics: recycle.

Other components: sort and dispose.



**NOTE!**

Risk of environmental harm through incorrect disposal!

Incorrect disposal can harm the environment.

Commission a specialized licensed firm to dispose of electrical waste, electronic components, lubricants and other auxiliary materials.

If in doubt, enquire how to ensure environmentally compatible disposal at your local council office or consult a specialist disposal firm.